

# Little Folks

- FURNITURE -

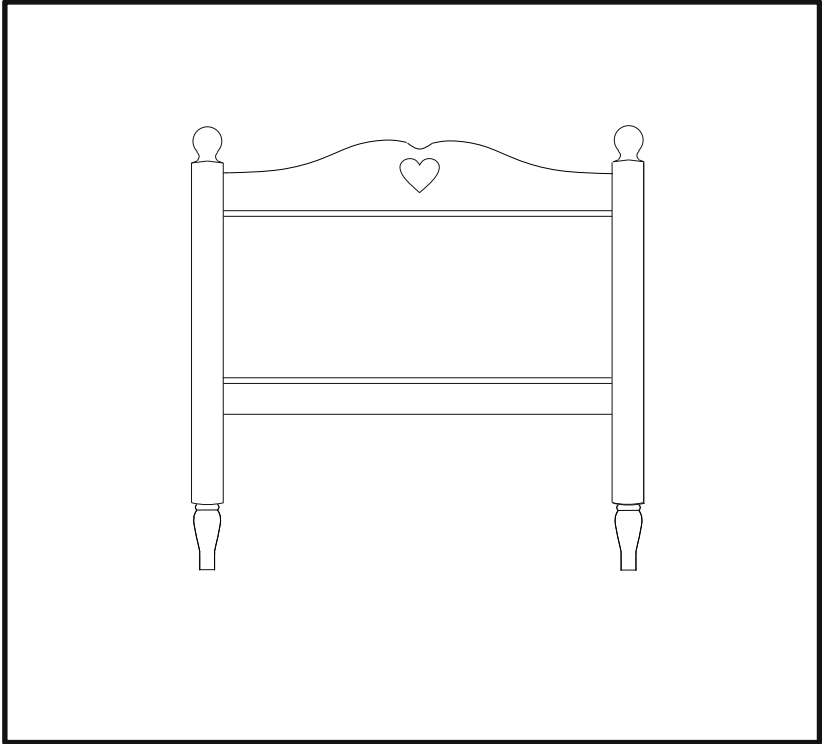

## Carved Heart Bed

Code: SBD003

PLEASE READ CAREFULLY & KEEP FOR FUTURE REFERENCE

Thank you for buying a **Little Folks** piece of furniture

Treated properly it should be a faithful servant for years - and we hope you get the same amount of pleasure from it. Before you do

- please take a few minutes to read these instructions
- we suggest you carefully unpack everything, lay it out on a clean, flat floor and identify everything on the parts list in these instructions. Do not throw away any packaging until you are sure you have all the parts.

If you have any problems assembling the product please call our customer services on 01985 300588 and we will try and help. If for any reason you wish to return the product, you must disassemble the product and pack in the original packaging.

## Taking care of your product

Your furniture should require no more than a regular dust off with a soft cloth. If the furniture is not painted then a superior wood polish can be used - but never use polishes containing silicone. If necessary it can be cleaned with a damp cloth with a mild detergent solution - and then dried with a lint-free cloth. Never clean with abrasives or chemical cleaners.

Direct sunlight or heat from a radiator can stain, discolour warp or crack furniture.

We know furniture can be heavy but try not to drag furniture across the floor as this can damage it.

## PRODUCT SAFETY

The recommended size of the mattress is 191cm x 90cm (6'3" x 3'0)

Periodically check all fittings to ensure that none have come loose.

Keep away from direct sources of heat, such as electric, gas or coal fires.

Do not allow children to Climb on the furniture.

Using this furniture other than for its intended purpose could cause damage to the structure or serious injury to your child.

The Bed should not be used if any structural part is broken or missing.

If you can manage it, please try to persuade your children not to bounce on the bed.

Warning: The child's bed should not be placed too close to other furniture or windows, blind cords, curtain pulls or other strings or cords, and should be placed either tight to any wall or have a gap of 300mm between the wall and the side of the bed.

If you have any problems please do contact us for help on e mail  
customerservices@littlefolksfurniture.co.uk or phone our

**CUSTOMER SERVICES**

**01985 300588**

## Parts list

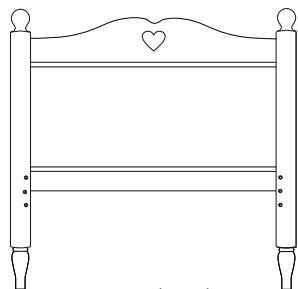

1x Head End

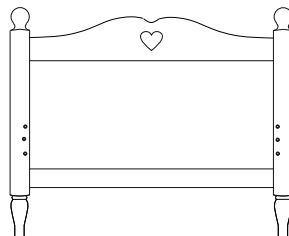

1x Foot End



2x Mattress Rails

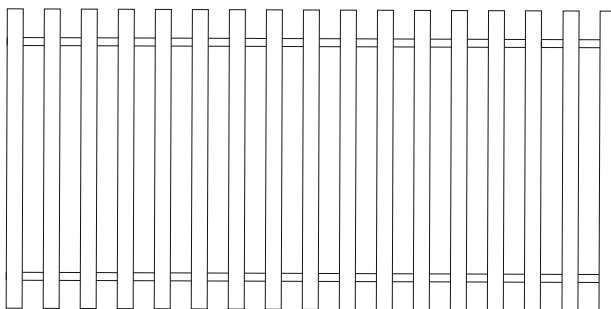

1x Mattress Base

## Fittings

4 x nuts, 4 x washers, 4 x spring washers & 4 x treaded bars

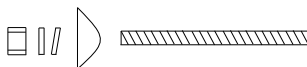

8 x Dowels



30 x Screws

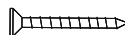

## Tools Req

Screwdriver

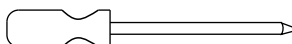

Spanner

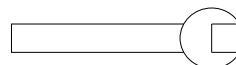

## Fitting the bed legs.

4 threaded bars and 8 wooden dowels

Insert and rotate each threaded bar into the centre hole on each bed leg. Now insert the wooden dowels into the two holes either side.

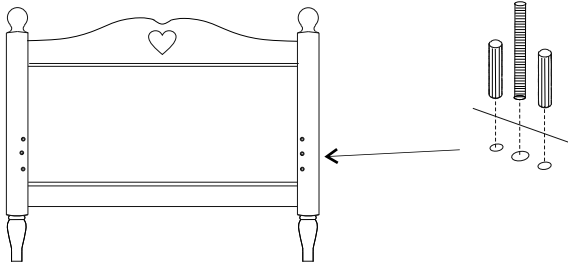

## Making the bed. (Two people required)

Slide each mattress rail onto the threaded bar and wooden dowels that you have fitted in the legs. Carefully slide the lunar washer onto the threaded bar as it passes through the large hole in each mattress rail. As this bar passes through the lunar washer slip on the spring washer then the normal washer and then finally the nut. Push the bed frame together. Rotate the nut using the spanner provided and tighten the bed frame.

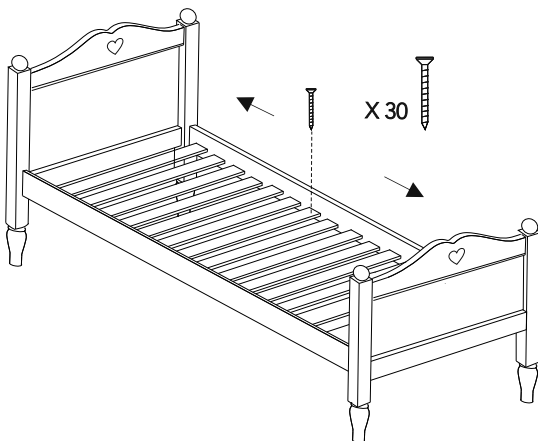
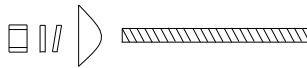
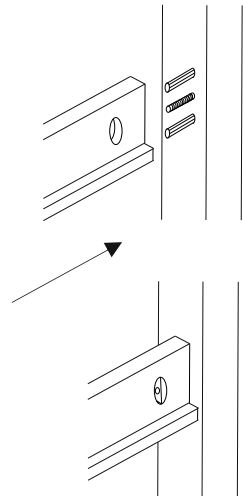

## Fix the base

30 x Wood screws

Lift the slatted base onto the bed, slide out and screw down.

Note: Both bed end slats should be tightly fitted at each end.